



**FABRICATED
PLASTICS LIMITED**



ARMOURPLASTICS®

THERMOPLASTIC LINED FRP ARMoured TANKS AND VESSELS



FABRICATED PLASTICS (FABCO) is well known for designing, engineering and fabricating quality equipment for the chemical industry since 1962. Fabco pioneered the use of thermoplastics like PVC, CPVC, PP, PVDF, E-CTFE, and FEP bonded to reinforced plastics to create a new family of materials called "Armourplastics®" (dual laminates). Today Armourplastics offer a cost effective alternative to titanium and corroding stainless steel.

ARMOURPLASTICS®

THERMOPLASTIC LINED FRP ARMoured TANKS AND VESSELS

Armourplastics® resist corrosion over a broad range of temperatures and are suited to both the most severe chemical services and for high purity applications where it is necessary to keep the process fluid totally free of contaminants.

Fabco has developed and acquired the best technology available for machine fusing liners, vacuum forming dished heads, flat radiused cornered bottoms and internal ledges. Modern microprocessor controlled filament winding machines are used to wind glass fibres saturated in resin to produce exceptionally strong and lightweight equipment. Fabco's craftsmen are trained in all fabrication techniques and undergo continuing development programs in welding and fusion theory and laminate construction. Fabco's Engineering department can supply design calculations and carry out quality control testing. The Fabco experience and technical expertise in the processing of Armourplastics® materials and its ability to do small and dimensionally large and critical equipment is unmatched and makes Fabco uniquely qualified to provide Armourplastics® of the highest quality.

WHY ARMOURPLASTICS® ?

Armourplastics® offer the design engineer the benefits of two dissimilar materials combined to make a superior alternative.

Thermoplastics display exceptional chemical resistance but have limited impact strength and poor physical properties when influenced by temperature. Reinforced Plastics on the other hand display excellent resistance to heat with full retention of physical properties are lightweight and exceptionally strong.

Thermoplastic liner materials are machined made, offering a corrosion liner that is homogeneous, uniform in thickness and having proven mechanical properties. The Thermoplastic liner when fabricated using machine fusion and properly bonded to the FRP armoring creates a dual laminate that exhibits the best properties of both materials combined in the Armourplastics® construction.

QUALITY FOREMOST

Fabco Thermoplastic lined vessels and equipment are built to meet your standards and expectations for quality products.

All Fabco Armourplastics® equipment is designed to enable the Thermoplastic liner to address the corrosion resistance needs of the application, while the FRP Armoring satisfies the structural requirements.

APPLICATIONS

- Storage Tanks
- Mixers
- Scrubbers
- Columns
- Towers
- Reactors

INDUSTRIES

- Bleaching Chemical
- Chemical Processing
- Semiconductor
- Pulp & Paper
- Mining
- Water Treatment
- Pharmaceutical
- Food and Beverage

FABRICATION TECHNIQUES

Proper fabrication, bonding and welding techniques are essential to the manufacturing of Armourplastics® equipment. Fabco craftsmen are trained in all techniques of fabrication. Our approach is to eliminate or minimize the number of hand welds. Most welds are done with modern fusion equipment insuring very high weld efficiency through machine controls. Weld maps are provided differentiating the types of seams used in our construction. Machine made vacuum formed dished heads and flat bottoms come standard on all common Armourplastics® tank / vessel diameters. Moulded ledges and formed face flanges are used as standard construction to provide superior fabrication techniques only weld rod identically compatible with the liner sheet material is used. All liners have carbon fibre backing strips applied to seams prior to FRP bonding to allow spark testing during the complete manufacturing process in order to detect any cracks or pinholes. An FRP armouring with high performance corrosion resistant resin includes a bonding layer and a secondary corrosion liner applied by hand followed by structural laminate applied by hand lay up and/or our microprocessor controlled filament winder. Additional testing can include hydrostatic, strain gauge, and acoustic emission testing.

MATERIAL SELECTION

The Thermoplastics in the Armourplastics® group are ideally suited for tank lining as they offer excellent corrosion resistance over a wide range of operating temperatures. Abrasion resistance and low coefficient of friction are some of the performance differences.

Machined made liners with tight extrusion standards and traceability coupled with maximum machine fusion of seams give the Armourplastics® equipment long service life and low maintenance.

GRAYKOR® PVC

(Polyvinyl Chloride) PVC is the most frequently specified of all thermoplastic materials. It has been used successfully for over 30 years in chemical processing areas.

PVC is characterized by high physical properties and resistance to corrosion and chemical attack by acids, alkalies, salt solutions and many other chemicals. It is attacked, however, by polar solvents such as ketones, some chlorinated hydrocarbons and aromatics.

ORANGEKOR® CPVC

(Chlorinated Polyvinyl Chloride) has physical properties at 73 F. similar to those of PVC, and its chemical resistance is similar to or generally better than PVC. CPVC, with a maximum service temperature of 210 F has, over a period of about 15 years, proven to be an excellent material for hot corrosive liquids, hot and cold water distribution and similar applications above the temperature range of PVC.

BLUEKOR® PP

(Polypropylene) is a polyolefin which is lightweight and generally high in chemical resistance. It is chemically resistant to organic solvents as well as acids and alkalies. Generally, polypropylene should not be used in contact with strong oxidizing acids, chlorinated hydrocarbons and aromatics. Polypropylene has gained wide acceptance where its resistance to sulfur bearing compounds is particularly useful in salt water disposal lines, crude oil piping and

low pressure gas gathering systems. Polypropylene has also proven to be an excellent material for laboratory and industrial drainage where mixtures of acids, bases and solvents are involved.

KEMKOR® PVDF

(Polyvinylidene Fluoride) is a thermoplastic with a maximum service temperature of 212 F. Regarding resistance for chemicals, it is unsuitable for use in strong alkalies, fuming acids, polar solvents, amines, ketones and esters. It has a high tensile strength and a high heat deflection temperature. It is easily welded, offers high-purity (non-contaminating) qualities, and is very resistant to permeation. In many applications, it is an excellent, lower cost alternative to PTFE or PFA.

HALINE ECTFE

(Ethylenechlorotrifluoro-ethylene) fluoropolymer is a strong, highly impact-resistant material that retains useful properties over a broad range of temperatures. Its low-temperature properties, especially those related to impact, are particularly outstanding. E-CTFE can tolerate elevated temperatures in the range of 300-340F.

E-CTFE fluoropolymer exhibits outstanding chemical resistance and excellent barrier properties. Among those substances that fluoropolymer is resistant to are strong mineral and oxidizing acids, alkalies, metal etchants, liquid oxygen and essentially all organic solvents except hot amines (e.g. aniline, dimethylamine). Typical of the fluoropolymers E-CTFE is attacked by metallic sodium and potassium. Rate of attack is a function of exposure time and temperature.

E-CTFE fluoropolymer has low permeability to water vapor and various other gases.

LINER MATERIALS AND SERVICE TEMPERATURES

LINER MATERIAL DESIGNATION	LINER THICKNESS MM	LINER COLOUR	BACKING MATERIAL	INSTALLATION METHOD	MAXIMUM OPERATING TEMPERATURE*	
					°F	°C
PVC PVC-CAW PVC-MZ	3 or 4 or 5	DARK GREY	NONE	CHEMICAL BOND	170°	77°
CPVC PVC-C-HT	3 or 4 or 5	LIGHT GREY /DARK GREY	NONE	CHEMICAL BOND	210°	99°
PP PP-DWU-SK PP-C-PK	3 or 4	TAN /GREY	POLYESTER / PP	MECHANICAL BOND	220°	105°
PVDF PVDF-SK	3 or 4	NATURAL	POLYESTER	MECHANICAL BOND	220°	105°
ECTFE ECTFE-GK ECTFE-SK	1.5 or 2.3	NATURAL	POLYESTER /GLASS	MECHANICAL BOND	250°	121°
FEP FEP-GGS	1.5 or 2.3	NATURAL	GLASS	MECHANICAL BOND	250°	121°
PFA PFA-GGS	1.5 of 2.3	NATURAL	GLASS	MECHANICAL BOND	250°	121°
FEP FEP/FEP	1.5 or 2.3	NATURAL	NONE	NON-BONDED	250°	121°

*OPERATING TEMPERATURE IS USUALLY DICTATED BY THE FRP RESINS MAXIMUM SERVICE TEMPERATURES.

PHYSICAL PROPERTIES OF THERMOPLASTICS AND REINFORCED PLASTIC MATERIALS

ASTM TEST METHODS	PROPERTIES	MATERIAL								
		PVC 12454-B	CPVC 23447-B	PVDF	POLYPROPYLENE	ECTFE	FEP	PFA	FRP*	
									HLU	FW**
General D-792	Specific Gravity	1.38	1.55	1.76	.905	1.70	2.15	2.15	1.45	1.70
D-570	Water Absorption % 24 Hrs. @ 73° F	.05	.05	.04	.02	-	-	-	-	-
Mechanical D-638	Tensile Strength psi @ 73° F	7,940	8,400	6,000	5,000	7,000	3,200	3,200	15,000	40,000
D-638	Modulus of Elasticity in Tension psi @ 73° F x 10 ⁵	4.2	4.2	2.1	1.7	2.4	0.5-0.7	0.4	10	30
D-790	Flexural Strength psi	14,500	15,600	9,700	7,000	6,400	2,600	2,600	25,000	60,000
D-256	Izod Impact Strength @ 73 F (Notched)	.65	3.0	3.8	1.3				1.5	40
Thermal D-696	Coefficient of Thermal Expansion in/in/°F x 10 ⁻³	3.0	3.8	7.9	5.0	3.6	5.5	7.8	1.7	0.6
C-177	Thermal Conductivity BTU/HR/Sq. Ft./°F/in	1.2	.95	.79	1.2	0.97	1.73	1.31	0.8	1.0
D-648	Heat Distortion Temp. °F @ 66 psi	N/A	238	284	220					
D-648	Heat Distortion Temp. ° F 264 psi	160	221	194	140	250	300	300	210-300	***
Flammability D-2863	Limiting Oxygen Index (%)	43	60	44	17	60	95	95	-	-
E-84	Flame Spread	15-20	15.00	0.00	N/A	-	-	-	15-350	***
	Underwriters Lab Rating (Sub.94)	94V-0	94V-0	94V-0	94HB	94V-0	94V-0	94V-0		

* FRP Properties presented herein represent average values as FRP is a custom designed system dependent on laminate construction resin type and fabrication method.

** Values for Filament Wound laminates shown are in the fiber direction.

*** Depending on resin type and additives.

TEFLINE® P-PFA

(Perfluoroalkoxy) has very similar properties to PTFE, but unlike PTFE, is a thermoplastic, providing processing advantages in certain applications. Its maximum service temperature is higher than PTFE and its chemical resistance is equal to PTFE. It is considered to be less permeable than PTFE in some applications and is excellent in high-purity (non-contaminating) services.

TEFLINE® F-FEP

(Fluorinated Ethylene Propylene)

Like PFA, FEP is a thermoplastic having similar chemical resistance properties of that of PTFE and PFA. It is relatively soft plastic with lower tensile strength, wear resistance, and creep resistance than PTFE or PFA. It has excellent permeation resistance to liquids and is available in bonded and non bonded applications.

TANK OPTIONS



Model C-CVF
Closed Vertical Flat Bottom

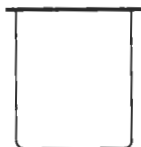

Model C-OVF
Open Vertical Flat Bottom

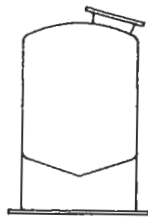

Model C-CVCS
Closed Vertical, Cone Skirted

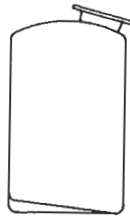

Model C-CVS
Closed Vertical Sloping Bottom

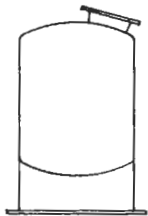

Model C-CVDS
Closed Vertical Dished Skirted

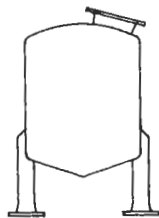

Model C-CVC
Closed Vertical Cone on Legs

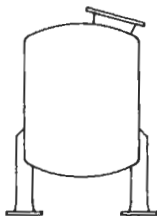

Model C-CV
Closed Vertical Dished on Legs

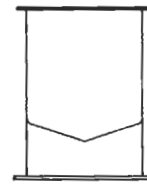

Model C-OVCS
Open Vertical, Cone Skirted

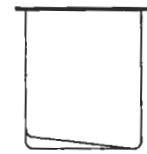

Model C-OVS
Open Vertical Sloping Bottom

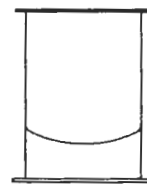

Model C-OVDS
Open Vertical Dished Skirted

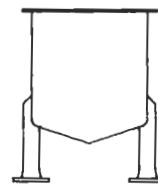

Model C-OVC
Open Vertical Cone on Legs

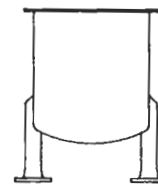

Model C-OV
Open Vertical Dished on Legs

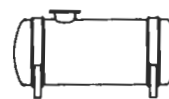

Model C-H
Horizontal Storage

Armourplastics® Equipment should not be shipped in below freezing conditions.

TANK ACCESSORIES

Hold Down and Lifting Lugs

Stainless steel hold down and lifting lugs are designed for specific tank sizes, weights and loading conditions.

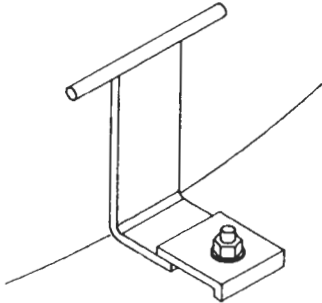

Stainless Steel Hold Down (Standard)

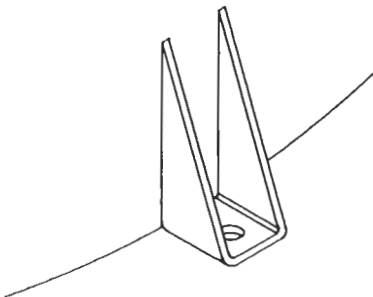

FRP Hold-Down (Optional)

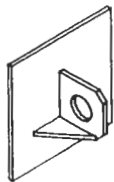

Stainless Steel Lifting Lug (Standard)

Flanged Nozzles and Flanged Drain Nozzles and Connections

All flanged nozzles are formed face and are drilled for ansi B16.5 150lb flanges are flat machined face and are gusseted up to 3" diameter.

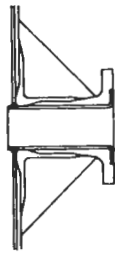

Formed Face Flanged Nozzle

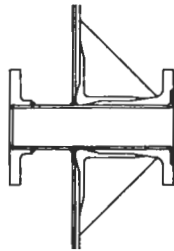

Formed Face Mounting Pad With Flanged Nozzle

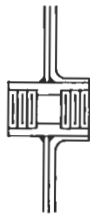

Coupling

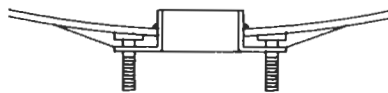

Stainless Steel Studs

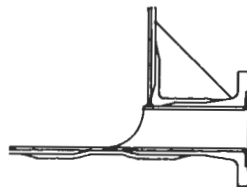

Full Drain Nozzle

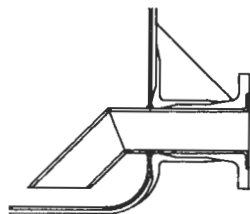

Siphon Drain Nozzle

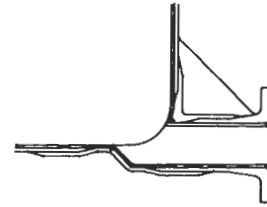

Complete Drain Nozzle

If full drainage is needed concrete pads must be recessed at drain locations.

VENTS

All closed top tanks must be vented to prevent creating a vacuum or developing excessive pressure. Vents are sized to be equal to or greater in diameter than the largest liquid inlet or outlet.

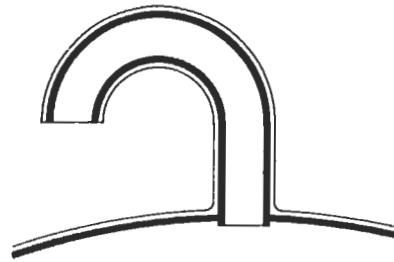

Goose Neck Vent

ACCESS MANWAYS:

Manways are flanged in 20" and 24" diameters and come complete with EPDM gasket and stainless steel bolting. Other gasket and bolting materials are available.

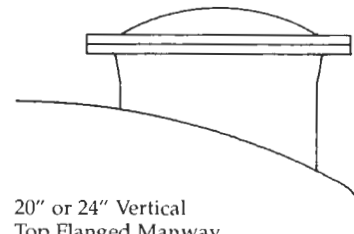

20" or 24" Vertical Top Flanged Manway

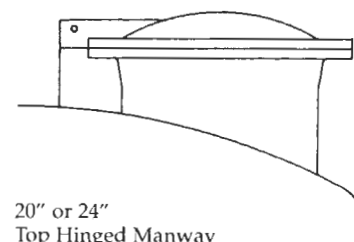

20" or 24" Top Hinged Manway

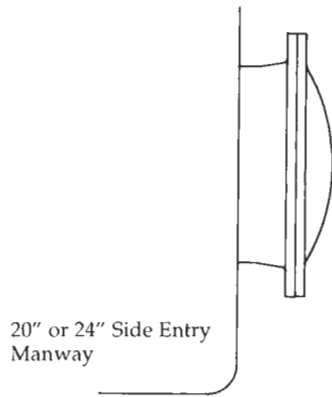

20" or 24" Side Entry Manway

AGITATOR MOUNTS

Various agitator mounts are available as required. FRP pads for C-clamps on small open top tanks, top or side nozzle mounts, and heavy duty steel I-beam cross supports for larger open or closed top tanks. Customer to provide agitator weight, bending moment, torque, and rpm plus blend time, liquid viscosity, and specific gravity for proper design.

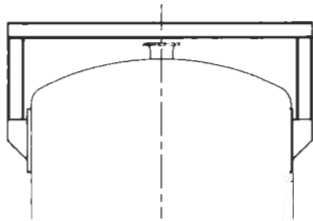

"I" Beam Agitator Support

MIXING BAFFLES

The number, size, structural design, and configuration are determined by the mixing requirements specified by the customer.

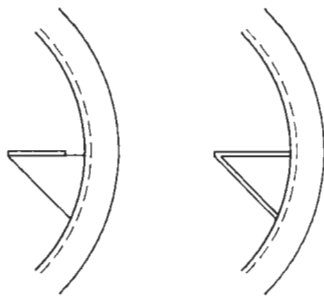
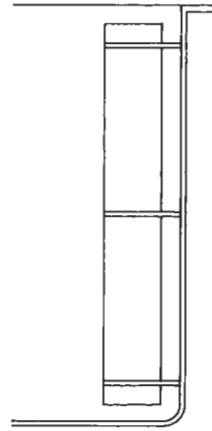

Plate Baffle

Wedge Baffle



Baffle Elevation

INSULATION - HEAT TRACING

Tanks can be supplied with closed cell polyurethane foam insulation. The foam is covered with a 125 mil FRP skin, which provides weather protection and protection during handling and installation. Electrical heat tracing or panels can be supplied with controls to provide freeze protection or maintain process temperatures. Customer to specify temperature desired, minimum ambient temperature, and voltage.

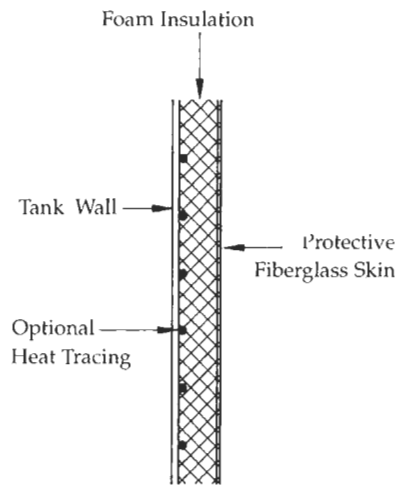

Foam Insulation

Tank Wall

Protective Fiberglass Skin

Optional Heat Tracing

LADDER AND CAGE

Aluminium, FRP or Carbon Steel Ladders and Cages

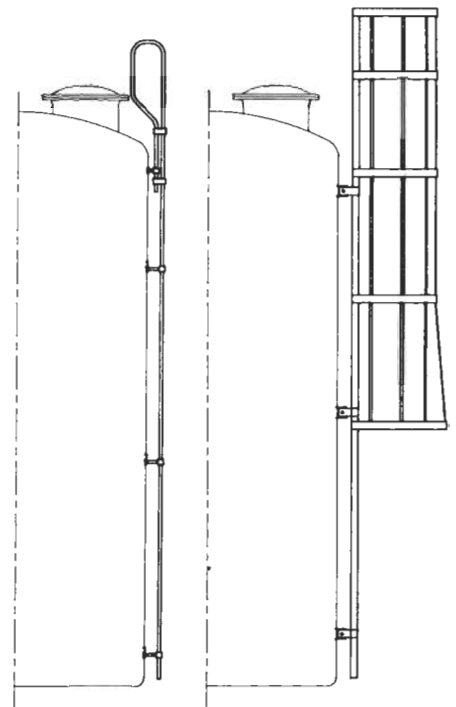

ADDITIONAL OPTIONS

- FRP or Steel Ladders and Cages
- FRP or Steel Platforms and Handrails
- Downpipes and Dip Tubes
- Piping Support Clips
- Level Indicators
- Calibration Gauges
- Sight Glass



DIAMETER & REQUIRED DIMENSION FOR SPECIFIC VOLUME

IMP GALLONS	US GALLONS	CUBIC METERS	TANK DIAMETER "D"														H L										
			FEET	3'	4'	5'	6'	6'6"	7'	8'	8'6"	9'	10'	11'	12'	13'1/2"		13'8"	14'								
			MM	914	1219	1524	1828	1981	2134	2438	2591	2743	3048	3353	3658	4000		4166	4267								
500	600	2.3	11.4	6.4	4.1																				H	L	
			11.1	6.0	3.6																					L	
1,000	1,201	4.5	22.8	12.8	8.2	5.7	4.9	4.2																		H	L
			22.4	12.4	7.7	5.1	4.2	3.5																		L	
2,000	2,402	9.1		25.6	16.4	11.4	9.7	8.4	6.4	5.7																H	L
				25.2	15.9	10.8	9.0	7.7	5.6	4.8																L	
3,000	3,603	13.6			24.6	17.1	14.5	12.5	9.6	8.5	7.6															H	L
					24.0	16.4	13.9	11.8	8.8	7.7	6.7															L	
4,000	4,804	18.2			32.8	22.8	19.4	16.7	12.8	11.3	10.1	8.2														H	L
					32.2	22.1	18.7	16.0	12.0	10.5	9.2	7.2														L	
5,000	6,005	22.7				28.4	24.2	20.9	16.0	14.2	12.6	10.2	8.5													H	L
						27.8	23.6	20.2	15.2	13.3	11.7	9.2	7.4													L	
6,000	7,205	27.3				34.1	29.1	25.1	19.2	17.0	15.2	12.3	10.2	8.5												H	L
						33.5	28.4	24.3	18.4	16.1	14.3	11.3	9.1	7.3												L	
8,000	9,607	36.4						33.4	25.6	22.7	20.2	16.4	13.5	11.4												H	L
								32.7	24.8	21.8	19.3	15.4	12.4	10.2												L	
10,000	12,009	45.5							32.0	28.3	25.3	20.5	16.9	14.2	11.9											H	L
									31.2	27.5	24.4	19.5	15.8	13.0	10.6											L	
12,000	14,411	54.6										24.6	20.3	17.1	14.3	13.2										H	L
												23.6	19.2	15.9	13.0	11.8										L	
14,000	16,813	63.6											28.7	23.7	19.9	16.6	15.3	14.6								H	L
													27.6	22.6	18.7	15.3	14.0	13.2								L	
15,000	18,014	68.2												30.7	25.4	21.3	17.8	16.4	15.7							H	L
														29.7	24.3	20.1	16.5	15.1	14.3							L	
18,000	21,616	81.8													30.5	25.6	21.4	19.7	18.8							H	L
															29.3	24.4	20.1	18.4	17.4							L	
20,000	24,018	90.9														28.4	23.8	21.9	20.9							H	L
																27.2	22.4	20.5	19.5							L	
25,000	30,023	113.7															35.6	29.7	27.4	26.1						H	L
																	34.3	28.4	26.0	24.7						L	
26,000	31,223	118.2																30.9	28.5	27.2						H	L
																		29.6	27.1	25.7						L	
30,000	36,027	136.4																	35.7	32.9	31.3					H	L
																			34.3	31.5	29.9					L	
35,000	42,032	159.1																		41.6	38.4	36.6				H	L
																				40.2	36.9	35.1				L	
40,000	48,036	181.8																			47.5	43.8	41.8			H	L
																					46.2	42.4	40.3			L	
45,000	54,041	204.6																				53.5	49.3	47.0		H	L
																						52.1	47.9	45.6		L	
50,000	60,045	227.3																					59.4	54.8	52.2	H	L
																							58.0	53.4	50.8	L	

**Tank Dimensions (Height /Length)
are shown in feet**

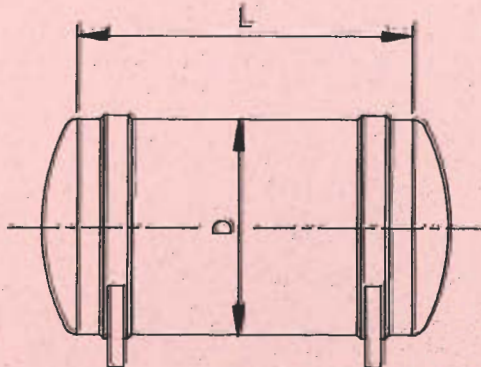
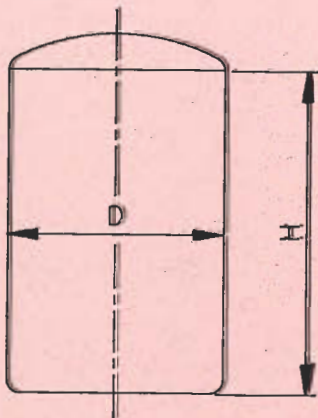



**FABRICATED
PLASTICS** LIMITED

■ ENGINEERING ■ FABRICATION ■ RESALE ■

TORONTO - 2175A Teston Road, Maple (Toronto), Ontario Canada L6A 1T3 Phone: (905) 832-0600 Fax: (905) 832-0992
Web Site: www.fabricatedplastics.com E-mail: info@fabcoplastics.com
EDMONTON - 12938 - 148 Street, Edmonton, Alberta T5L 2H8 Phone: (780) 451-0238 Fax: (780) 455-4816 E-mail: edmonton@fabcoplastics.com
VANCOUVER - 9511 - 194A Street, Surrey, B.C. V4N 4G4 Phone: 1-800-661-7926 Fax: (604) 882-1432 E-mail: surrey@fabcoplastics.com
MONTREAL - 16 Ronald Drive, Montreal West, Québec H4X 1M8 Phone: (514) 369-4720 Fax: (514) 369-5736 E-mail: montreal@fabcoplastics.com